

# Kit 1427

**TOYOTA Belta (Mk.II)**, 4-dr Sedan, 05-10

**TOYOTA Vios (Mk.II)**, 4-dr Sedan, 05-11

**TOYOTA Vitz**, 5-dr Hatchback, 05-09

**TOYOTA Vitz**, 5-dr Hatchback, 10-

**TOYOTA Yaris (Mk.II)**, 4-dr Sedan, 05-11

**TOYOTA Yaris**, 4-dr Sedan, \*07-11

**TOYOTA Yaris**, 5-dr Hatchback, 05-11 / \*07-11

**TOYOTA Yaris**, 5-dr Hatchback, 12-

\*North America

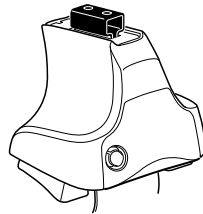

**754** Rapid System  
**480R** Rapid Traverse (North America)

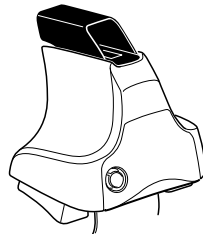
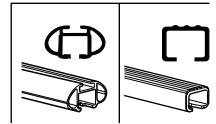

**480** Traverse (North America)

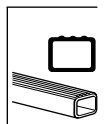

754 Rapid System  
480R Rapid Traverse (North America)

480 Traverse (North America)

**Kit**

1



2



754 Rapid System  
480R Rapid Traverse  
(North America)

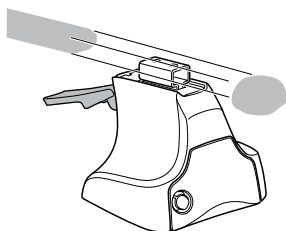

x4

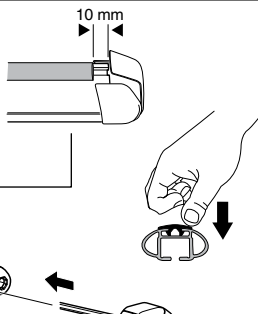
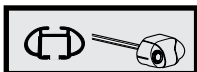

x4

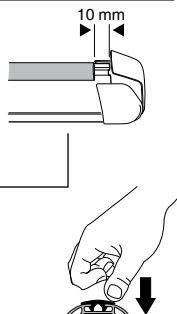
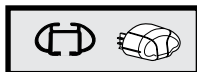

x4



480 Traverse  
(North America)

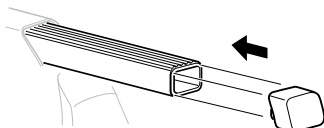

x4

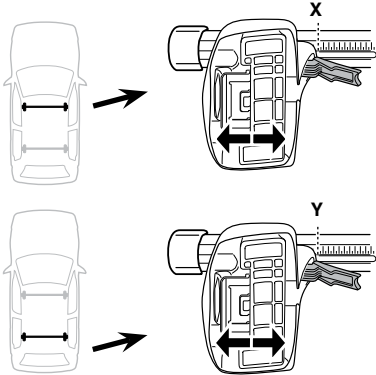
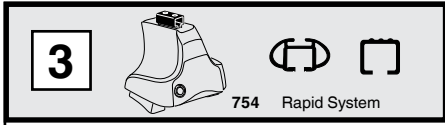

	X
<b>TOYOTA Belta (Mk.II)</b> , 4-dr Sedan, 05-10	<b>26,5</b>
<b>TOYOTA Vios (Mk.II)</b> , 4-dr Sedan, 05-11	<b>26,5</b>
<b>TOYOTA Vitz</b> , 5-dr Hatchback, 05-09	<b>28,5</b>
<b>TOYOTA Vitz</b> , 5-dr Hatchback, 10-	<b>26,5</b>
<b>TOYOTA Yaris (Mk.II)</b> , 4-dr Sedan, 05-11	<b>26,5</b>
<b>TOYOTA Yaris</b> , 4-dr Sedan, *07-11	<b>26,5</b>
<b>TOYOTA Yaris</b> , 5-dr Hatchback, 05-11 / *07-11	<b>28,5</b>
<b>TOYOTA Yaris</b> , 5-dr Hatchback, 12-	<b>26,5</b>

	Y
<b>TOYOTA Belta (Mk.II)</b> , 4-dr Sedan, 05-10	<b>26</b>
<b>TOYOTA Vios (Mk.II)</b> , 4-dr Sedan, 05-11	<b>26</b>
<b>TOYOTA Vitz</b> , 5-dr Hatchback, 05-09	<b>24,5</b>
<b>TOYOTA Vitz</b> , 5-dr Hatchback, 10-	<b>24,5</b>
<b>TOYOTA Yaris (Mk.II)</b> , 4-dr Sedan, 05-11	<b>26</b>
<b>TOYOTA Yaris</b> , 4-dr Sedan, *07-11	<b>26</b>
<b>TOYOTA Yaris</b> , 5-dr Hatchback, 05-11 / *07-11	<b>24,5</b>
<b>TOYOTA Yaris</b> , 5-dr Hatchback, 12-	<b>24,5</b>

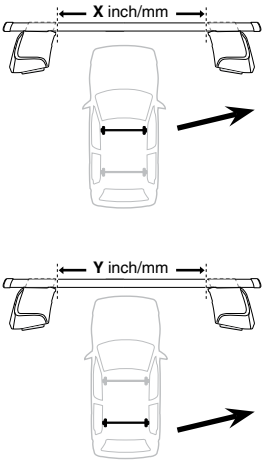
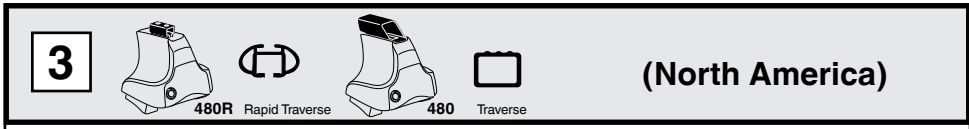

	X inch	X mm
<b>TOYOTA Belta (Mk.II)</b> , 4-dr Sedan, 05-10	<b>36 1/8"</b>	<b>916 mm</b>
<b>TOYOTA Vios (Mk.II)</b> , 4-dr Sedan, 05-11	<b>36 1/8"</b>	<b>916 mm</b>
<b>TOYOTA Vitz</b> , 5-dr Hatchback, 05-09	<b>36 7/8"</b>	<b>936 mm</b>
<b>TOYOTA Vitz</b> , 5-dr Hatchback, 10-	<b>36 1/8"</b>	<b>916 mm</b>
<b>TOYOTA Yaris (Mk.II)</b> , 4-dr Sedan, 05-11	<b>36 1/8"</b>	<b>916 mm</b>
<b>TOYOTA Yaris</b> , 4-dr Sedan, *07-11	<b>36 1/8"</b>	<b>916 mm</b>
<b>TOYOTA Yaris</b> , 5-dr Hatchback, 05-11 / *07-11	<b>36 7/8"</b>	<b>936 mm</b>
<b>TOYOTA Yaris</b> , 5-dr Hatchback, 12-	<b>36 1/8"</b>	<b>916 mm</b>

	Y inch	Y mm
<b>TOYOTA Belta (Mk.II)</b> , 4-dr Sedan, 05-10	<b>35 7/8"</b>	<b>911 mm</b>
<b>TOYOTA Vios (Mk.II)</b> , 4-dr Sedan, 05-11	<b>35 7/8"</b>	<b>911 mm</b>
<b>TOYOTA Vitz</b> , 5-dr Hatchback, 05-09	<b>35 1/4"</b>	<b>896 mm</b>
<b>TOYOTA Vitz</b> , 5-dr Hatchback, 10-	<b>35 1/4"</b>	<b>896 mm</b>
<b>TOYOTA Yaris (Mk.II)</b> , 4-dr Sedan, 05-11	<b>35 7/8"</b>	<b>911 mm</b>
<b>TOYOTA Yaris</b> , 4-dr Sedan, *07-11	<b>35 7/8"</b>	<b>911 mm</b>
<b>TOYOTA Yaris</b> , 5-dr Hatchback, 05-11 / *07-11	<b>35 1/4"</b>	<b>896 mm</b>
<b>TOYOTA Yaris</b> , 5-dr Hatchback, 12-	<b>35 1/4"</b>	<b>896 mm</b>

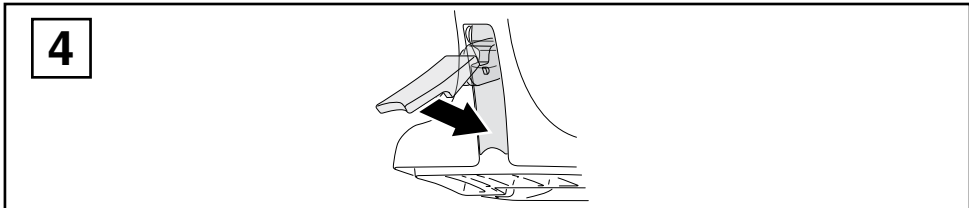

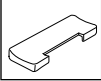
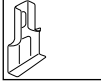
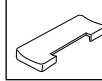
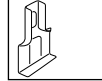
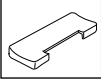
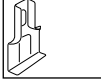
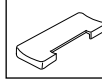
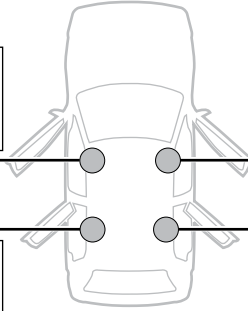
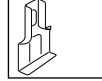
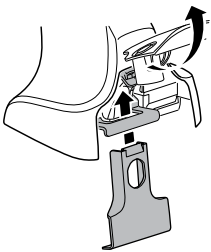
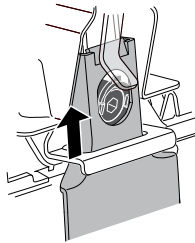
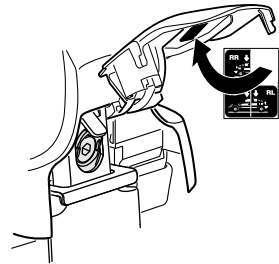
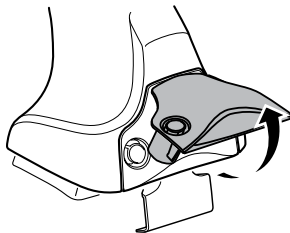
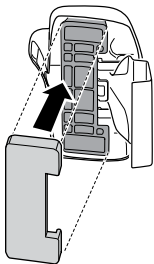
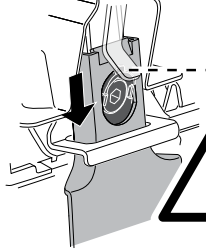
**5****TOYOTA Belta (Mk.II), 4-dr Sedan, 05-10****TOYOTA Vios (Mk.II), 4-dr Sedan, 05-11****TOYOTA Vitz, 5-dr Hatchback, 05-09****TOYOTA Vitz, 5-dr Hatchback, 10-****TOYOTA Yaris (Mk.II), 4-dr Sedan, 05-11****TOYOTA Yaris, 4-dr Sedan, \*07-11****TOYOTA Yaris, 5-dr Hatchback, 05-11 / \*07-11****TOYOTA Yaris, 5-dr Hatchback, 12-****229****745****228****745****23****860****24****860****A****B****C**

6

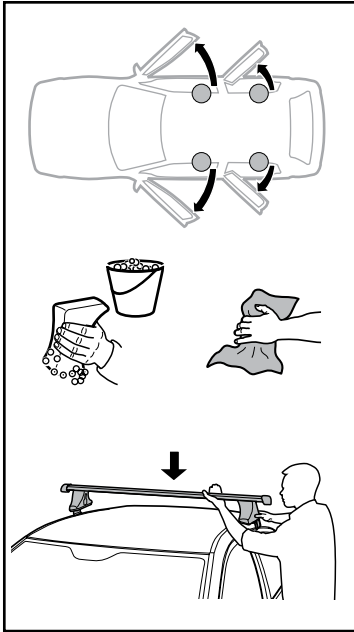

i

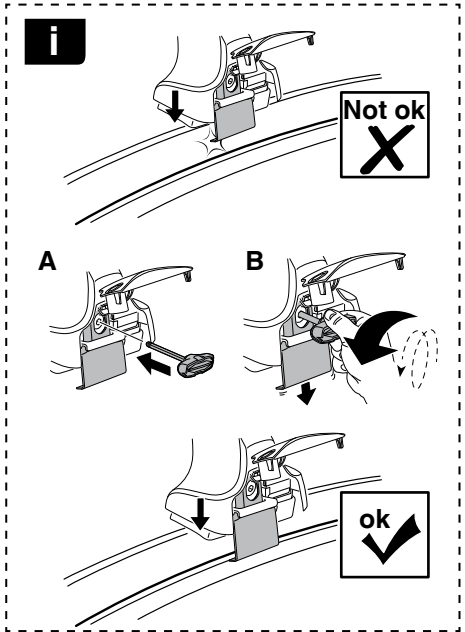

	X mm	Y mm	X inch	Y inch
TOYOTA Belta (Mk.II), 4-dr Sedan, 05-10	190 mm	710 mm	7 1/4"	28"
TOYOTA Vios (Mk.II), 4-dr Sedan, 05-11	190 mm	710 mm	7 1/4"	28"
TOYOTA Vitz, 5-dr Hatchback, 05-09	130 mm	710 mm	5 1/8"	28"
TOYOTA Vitz, 5-dr Hatchback, 10-	190 mm	710 mm	7 1/4"	28"
TOYOTA Yaris (Mk.II), 4-dr Sedan, 05-11	190 mm	710 mm	7 1/4"	28"
TOYOTA Yaris, 4-dr Sedan, *07-11	190 mm	710 mm	7 1/4"	28"
TOYOTA Yaris, 5-dr Hatchback, 05-11 / *07-11	130 mm	710 mm	5 1/8"	28"
TOYOTA Yaris, 5-dr Hatchback, 12-	190 mm	710 mm	7 1/4"	28"

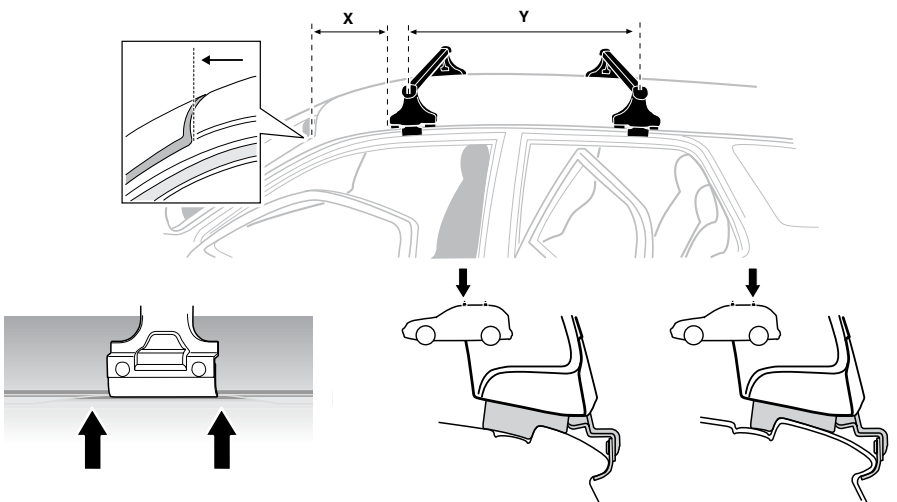

7



<b>GB/US</b>	Tighten alternately
<b>D</b>	Die Schrauben abwechselnd anziehen
<b>F</b>	Serrer alternativement chaque côté
<b>NL</b>	Afwisselend aan de linker- en de rechterkant aandraaien
<b>I</b>	Alternare il serraggio delle viti
<b>E</b>	Apertar alternativamente
<b>PT</b>	Aperte alternadamente
<b>S</b>	Dra åt växelvis
<b>FIN</b>	Kierrä vuorotellen
<b>EST</b>	Pinguldage vaheldumisi
<b>LAT</b>	Pielveiciet pamišus
<b>LIT</b>	Užsukinėkite pakaitomis
<b>PL</b>	Śruby dokręcaj naprzemiennie
<b>RU</b>	Загряивайте попеременно

<b>CZ</b>	Pokręřta багаžnika dokręcaj dokręcaj naprzemiennie.
<b>SK</b>	Dofahajte striedavo
<b>SLO</b>	Privijajte izmenično.
<b>HR</b>	Naizmjenično zategnite
<b>HU</b>	Egymástól függetlenül szorítandó
<b>GR</b>	Σφιγίγες ενολάξ
<b>TR</b>	Dönüşümlü sıkın

**中文** 交替拧紧

**한국어** 번갈아 가며 조이십시오.

**日本語** 交互に締め付けてください。

**ไทย** ชันในแบบสลับ

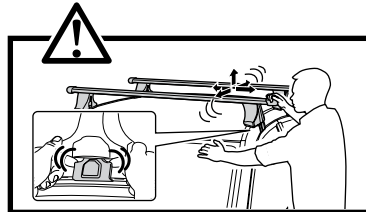
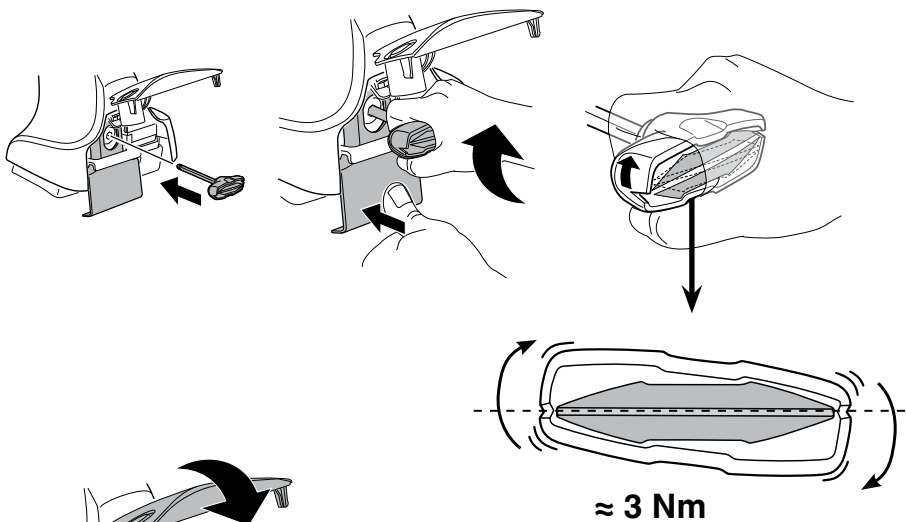

8



x1  
17 mm

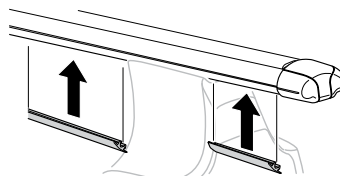
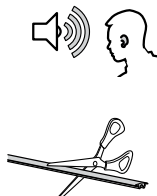

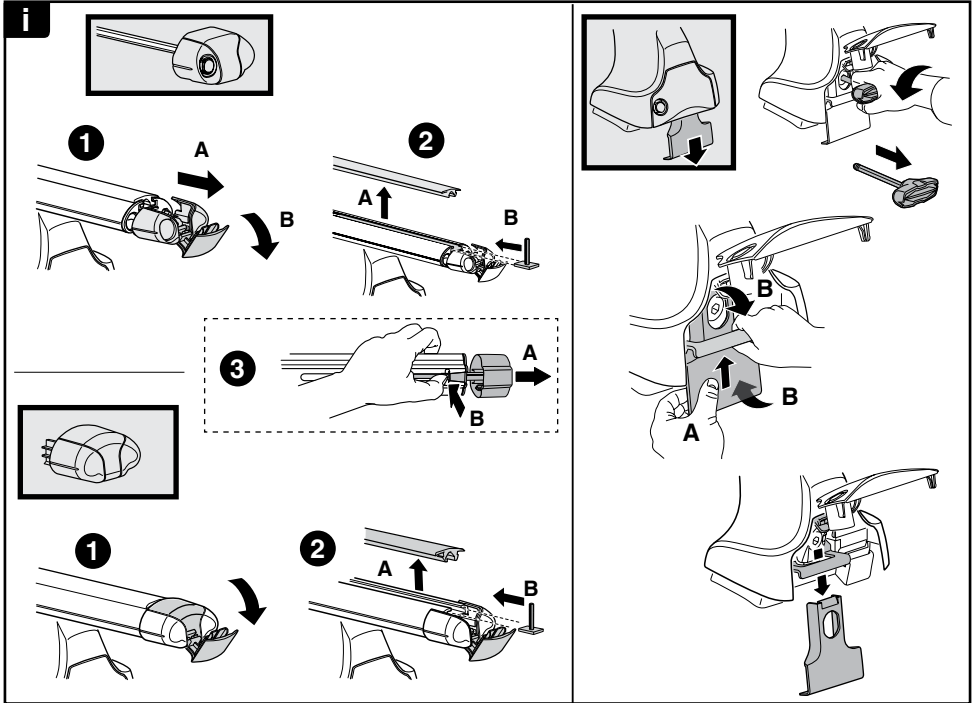

**THULE**  
SWEDEN  
**ONE  
KEY  
SYSTEM**

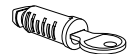
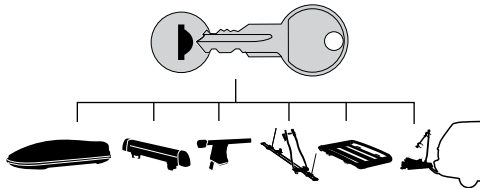

- 544** (x4)
- 596** (x6)
- 588** (x8)
- NA **510** (x10)
- EUR **452** (x12)
- ASIA

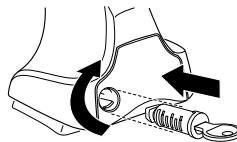

WW ▶ Thule Sweden AB, Box 69, 330 33 Hillerstorp, SWEDEN  
NA ▶ Thule Inc., 42 Silvermine Road, Seymour, Connecticut 06483, USA

info@thule.com  
customer.service@thule.com

 www.thule.com

503-1427-04