



Thule XT Kit 3143

> Instructions

OPEL/ VAUXHALL Corsa E, 3-dr Hatchback, 15-

OPEL/ VAUXHALL Corsa E, 5-dr Hatchback, 15-

OPEL/ VAUXHALL Corsavan, 3-dr Van, 15-

This kit is only for vehicles with fixpoint mounting.

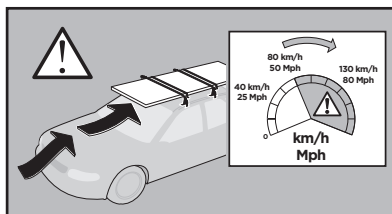
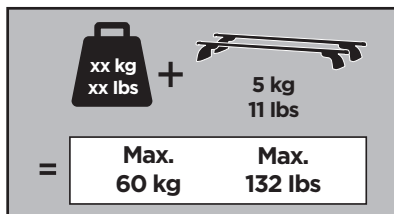
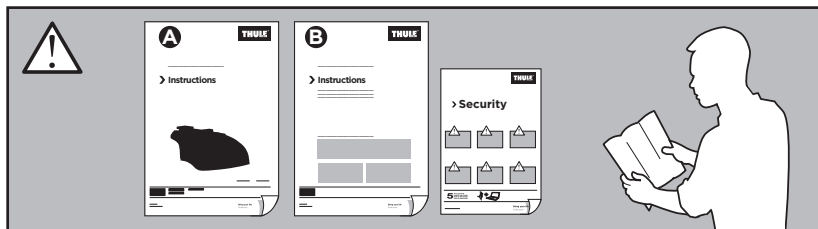

ISO 11154-E

183143

C.20150917
509-3143-02

Bring your life

thule.com

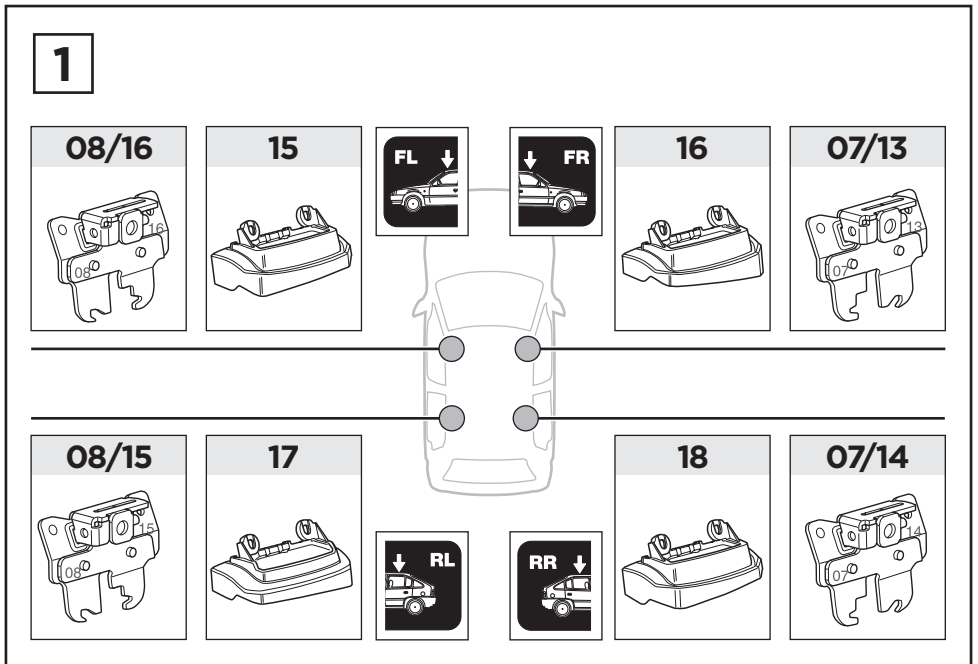
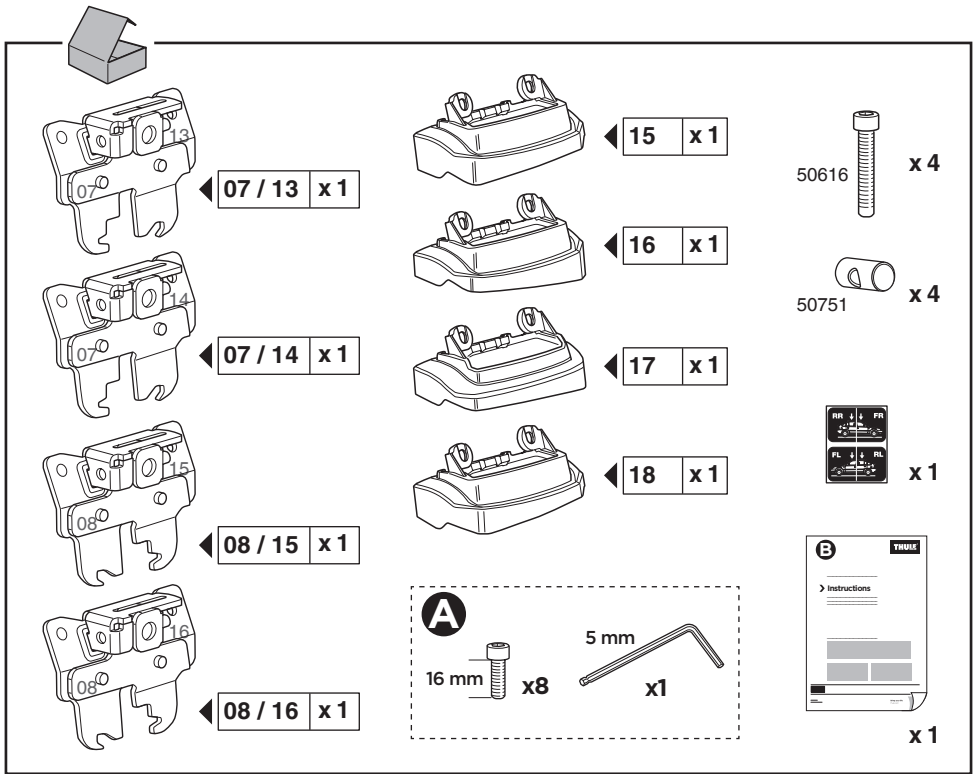

2

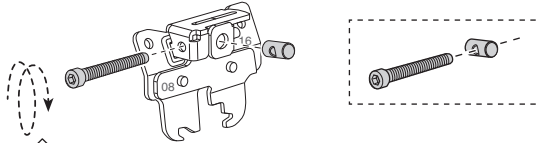
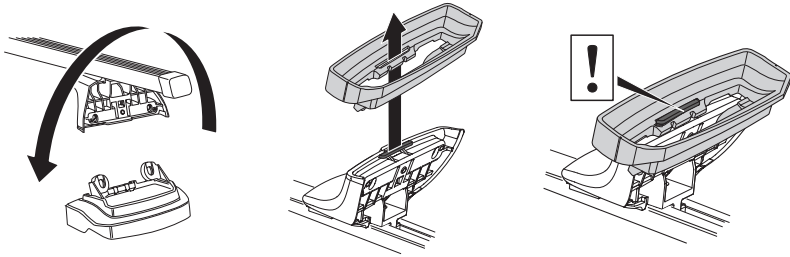

- | | | |
|-------------------------------------|-------------------------------------|----------------------------------|
| EN Only a few turns | ET Ainult mõni pööre | RO Doar câteva rotiri |
| DE Nur wenige Umdrehungen | LV Tikai dažī apgriezieni | HU Csak néhány fordítás |
| FR Quelques tours uniquement | LT Tik keli pasukimai | EL Μόνο λίγες περιστροφές |
| NL Slechts enkele slagen | PL Wystarczy kilka obrotów | TR Yalnızca birkaç tur |
| IT Solo qualche giro | RU Только несколько оборотов | AR بعض دورات فقط |
| ES Sólo algunas vueltas | UK Лише декілька обертів | HE רק מספר סיבובים |
| PT Apenas algumas voltas | BG Само няколко завъртания | ZH 仅几圈 |
| SV Endast några varv | CS Pouze několik otáček | JA 2～3回転のみ |
| DK Kun nogle få omgange | SK Len niekoľko otáčok | KO 몇 번만 돌리면 됨 |
| NO Bare noen få omdreinger | SL Le nekaj obratov | TH เพียงสองสามรอบ |
| FI Vain muutama kierros | HR/BIH Samo nekoliko okreta | |

A

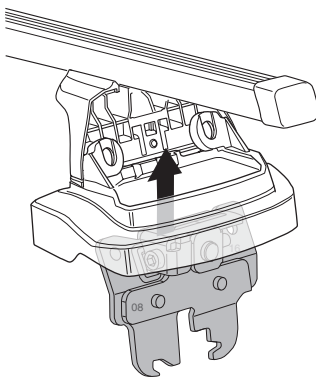

B

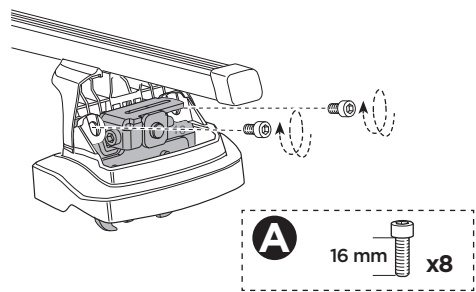

C

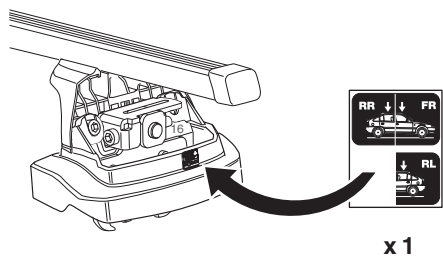

3

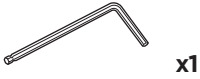

A

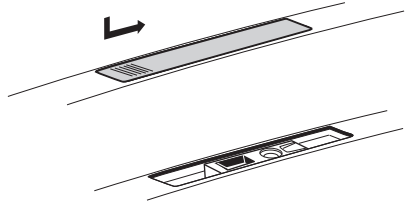
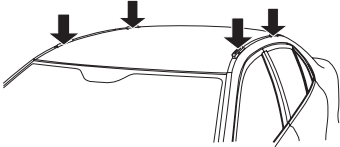

B

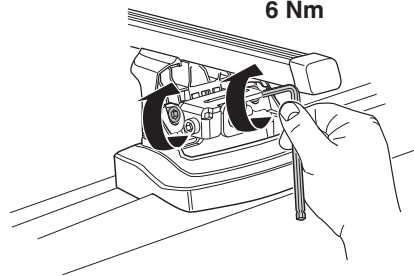
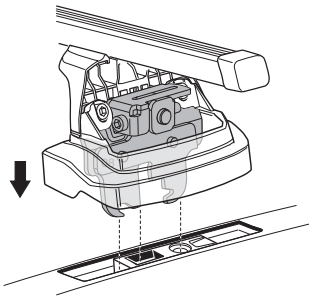

C

